

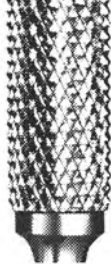





БОР-ФРЕЗЫ

ВИДЫ НАСЕЧЕК

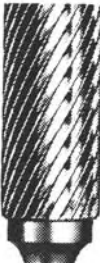
Насечка 1	Цветные металлы (Aluminium) Особенно хорошо подходит при обработке алюминия, магния, пластмассы, эбонита и т.п. Характеристики этого типа облегчают быстрое премещение стружки, предотвращающее от засорения инструмента.	Алмазная Рекомендуется для сталей высоколегированного сплава, нержавеющей сталей, сплавов магния, серого литейного чугуна и сплавов никелем.	Насечка 4		
		Насечка 2	Крупная Рекомендуется для мягких материалов, бронзы, латуни, олова, цинка, меди и т.п.	Мелкая Мелкая насечка. Особенно подходит для закаленной стали до 66 HRC и для того, чтобы получать высокое качество поверхности.	Насечка 5
		Насечка 3	Средняя Стандартное сечение. Рекомендуется для обработки стали (включая закаленные), сварных швов, и почти всех металлических материалов.	Двойная Универсальное сечение, подходит для обработки всех металлических материалов, включая закаленную и нержавеющую стали. Хороший съем материала при высоком качестве поверхности.	Насечка 6
		SP	Стружколом Использование рекомендуется для того, чтобы работать с материалами, где необходимо дробление стружки.	Торцевая Рекомендуется, когда требуется торцевая обработка.	ST
		При заказе укажите форму и номер насечки			

БОРФРЕЗЫ	ФОРМА	СТР.	ЭСКИЗ
ЦИЛИНДРИЧЕСКАЯ	30	12	
МАЛАЯ ЦИЛИНДРИЧЕСКАЯ	40	12	
ЦИЛИНДРИЧЕСКАЯ С ТОРЦЕВОЙ НАСЕЧКОЙ	30ST	13	
МАЛАЯ ЦИЛИНДРИЧЕСКАЯ С ТОРЦЕВОЙ НАСЕЧКОЙ	40ST	13	
ЦИЛИНРИЧЕСКАЯ СО СФЕРОЙ	31	14	
МАЛАЯ ЦИЛИНРИЧЕСКАЯ СО СФЕРОЙ	41	14	
КОНИЧЕСКАЯ СО СФЕРОЙ 14°	32	15	
МАЛАЯ КОНИЧЕСКАЯ СО СФЕРОЙ 14°	42	15	
ПЛАМЕВИДНАЯ СО СФЕРОЙ	33	16	
МАЛАЯ ПЛАМЕВИДНАЯ СО СФЕРОЙ	43	16	
ПЛАМЕВИДНАЯ	34	17	
МАЛАЯ ПЛАМЕВИДНАЯ	44	17	
КОНИЧЕСКАЯ	35	18	
МАЛАЯ КОНИЧЕСКАЯ	45	18	
КОНИЧЕСКАЯ 90°	36	19	
МАЛАЯ КОНИЧЕСКАЯ 90°	46	19	
КОНИЧЕСКАЯ 60°	36	20	
МАЛАЯ КОНИЧЕСКАЯ 60°	46	20	
ОВАЛЬНАЯ	37	21	
МАЛАЯ ОВАЛЬНАЯ	47	21	
СФЕРИЧЕСКАЯ	38	22	
МАЛАЯ СФЕРИЧЕСКАЯ	48	22	
ОБРАТНЫЙ КОНУС 15°	39	23	
МАЛАЯ ОБРАТНЫЙ КОНУС 15°	49	23	
ОБРАТНЫЙ КОНУС 15° С ТОРЦЕВОЙ НАСЕЧКОЙ	39ST	24	
МАЛАЯ ОБРАТНЫЙ КОНУС 15° С ТОРЦЕВОЙ НАСЕЧКОЙ	49ST	24	
НАБОРЫ		25	
ШЛИФОВАЛЬНАЯ МАШИНА		25	

30
ЦИЛИНДРИЧЕСКАЯ

по DIN 8033

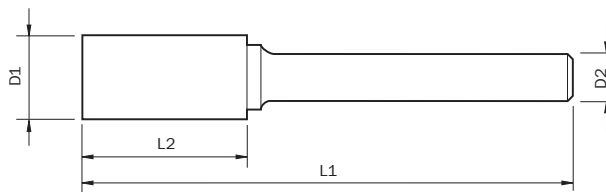

КОД	D1 mm	D2 mm	L2 mm	L1 mm
300406	4	6	14	50
300606	6	6	18	50
300806	8	6	18	63
301006	10	6	20	65
301206	12	6	25	70
301606	16	6	25	70
301608	16	8	25	70
302006	20	6	25	70
302008	20	8	25	70

Для заказа укажите:

- Код
- Тип насечки

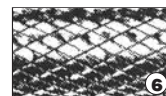
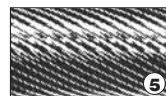
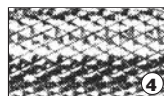
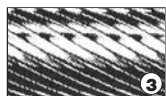
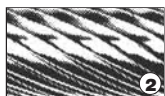
40
МАЛАЯ ЦИЛИНДРИЧЕСКАЯ

по DIN 8033

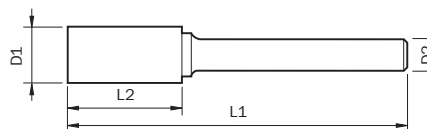
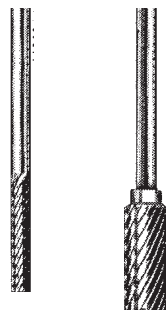

КОД	D1 mm	D2 mm	L2 mm	L1 mm
4063	6	3	14	49
4053	5	3	12	47
4043	4	3	10	45
4033	3	3	14	40
4025	2,5	3	12	40
4020	2	3	10	40
4015	1,5	3	8	40

ХВОСТОВИК Ø 2,35

2063	6	2,35	14	49
2053	5	2,35	12	47
2043	4	2,35	10	45
2020	2,35	2,35	12	40
2015	1,5	2,35	8	40

Для заказа укажите:

- Код
- Тип насечки

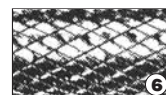
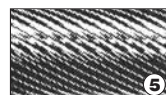
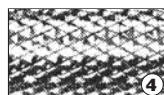
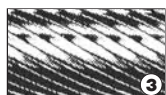
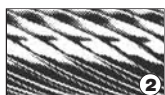

ЦИЛИНДРИЧЕСКАЯ С ТОРЦЕВОЙ НАСЕЧКОЙ

30ST

по DIN 8033

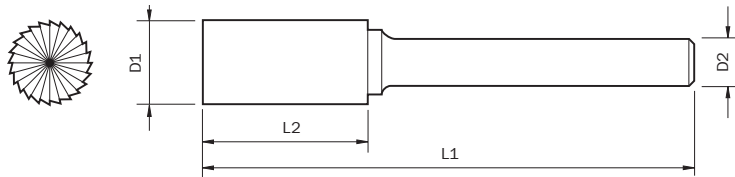

КОД	D1 mm	D2 mm	L2 mm	L1 mm
300406-ST	4	6	14	50
300606-ST	6	6	18	50
300806-ST	8	6	18	63
301006-ST	10	6	20	65
301206-ST	12	6	25	70
301606-ST	16	6	25	70
301608-ST	16	8	25	70
302006-ST	20	6	25	70
302008-ST	20	8	25	70

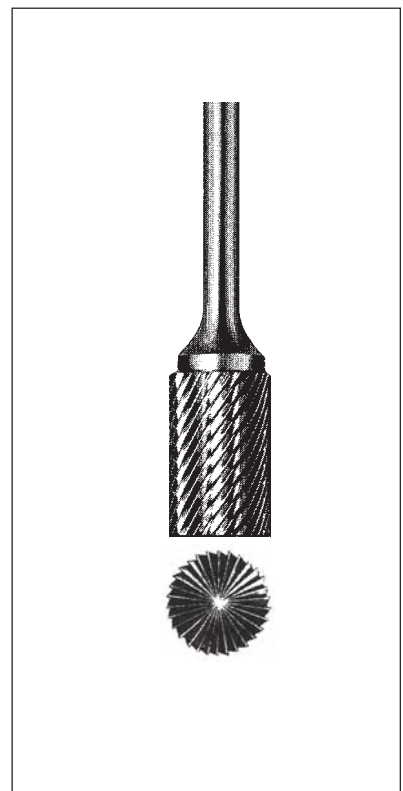

Для заказа укажите:

- Код
- Тип насечки



МАЛАЯ ЦИЛИНДРИЧЕСКАЯ С ТОРЦЕВОЙ НАСЕЧКОЙ

40ST

по DIN 8033

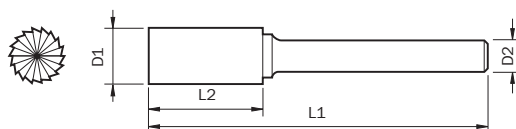

КОД	D1 mm	D2 mm	L2 mm	L1 mm
4063-ST	6	3	14	49
4053-ST	5	3	12	47
4043-ST	4	3	10	45
4033-ST	3	3	14	40
4025-ST	2,5	3	12	40
4020-ST	2	3	10	40
4015-ST	1,5	3	8	40

ХВОСТОВИК \varnothing 2,35

2063-ST	6	2,35	14	49
2053-ST	5	2,35	12	47
2043-ST	4	2,35	10	45
2020-ST	2,35	2,35	12	40
2015-ST	1,5	2,35	8	40

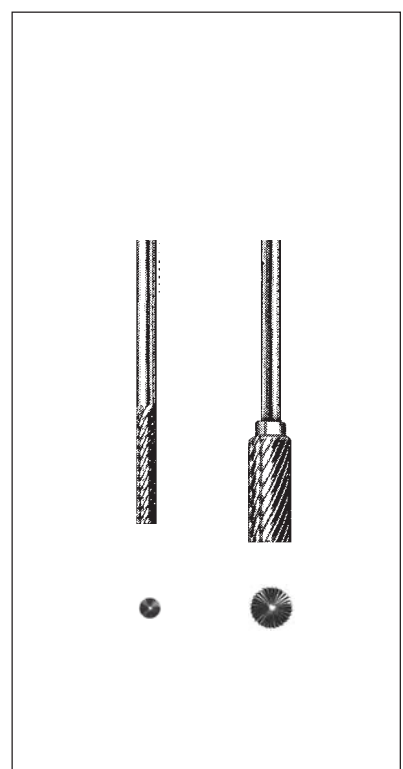

Для заказа укажите:

- Код
- Тип насечки

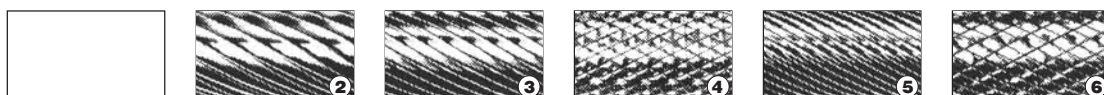

31
ЦИЛИНДРИЧЕСКАЯ СО СФЕРОЙ

по DIN 8033

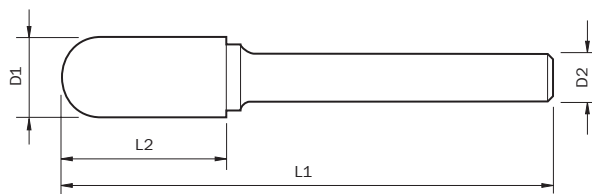

КОД	D1 mm	D2 mm	L2 mm	L1 mm
310406	4	6	14	50
310606	6	6	18	50
310806	8	6	18	63
311006	10	6	20	65
311206	12	6	25	70
311606	16	6	25	70
311608	16	8	25	70
312006	20	6	25	70
312008	20	8	25	70

Для заказа укажите:

- Код
- Тип насечки

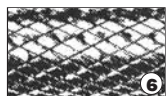
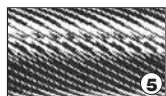
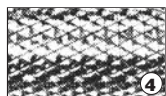
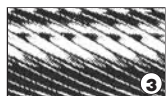
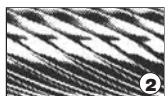
41
МАЛАЯ ЦИЛИНДРИЧЕСКАЯ СО СФЕРОЙ

по DIN 8033

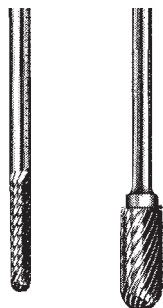
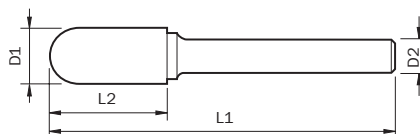

КОД	D1 mm	D2 mm	L2 mm	L1 mm
4163	6	3	14	49
4153	5	3	12	47
4143	4	3	10	45
4133	3	3	14	40
4125	2,5	3	12	40
4120	2	3	10	40
4115	1,5	3	8	40

ХВОСТОВИК \varnothing 2,35

2163	6	2,35	14	49
2153	5	2,35	12	47
2143	4	2,35	10	45
2120	2,35	2,35	12	40
2115	1,5	2,35	8	40

Для заказа укажите:

- Код
- Тип насечки

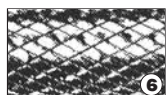
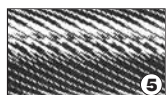
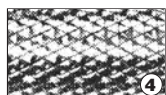
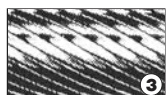
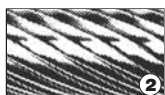

КОНИЧЕСКАЯ СО СФЕРОЙ 14°

по DIN 8033

32

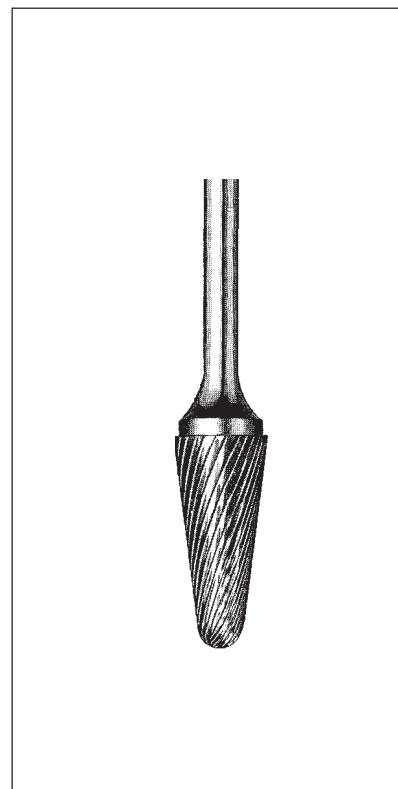
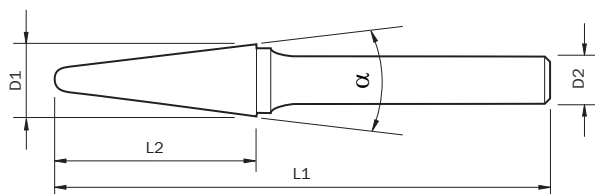

КОД	D1 mm	D2 mm	L2 mm	L1 mm	K mm	α
320406	4	6	14	50	0,8	14°
320606	6	6	20	50	1	14°
320806	8	6	24	69	1,3	14°
321006	10	6	28	73	2	14°
321206	12	6	30	75	2,6	14°
321606	16	6	38	83	4	14°
321608	16	8	38	83	4	14°
322006	20	6	42	87	5,5	14°
322008	20	8	42	87	5,5	14°

Для заказа укажите:

- Код
- Тип насечки

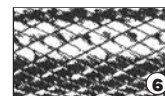
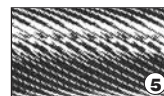
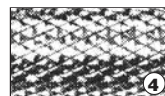
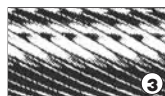
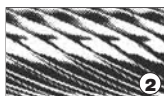

МАЛАЯ КОНИЧЕСКАЯ СО СФЕРОЙ 14°

по DIN 8033

42

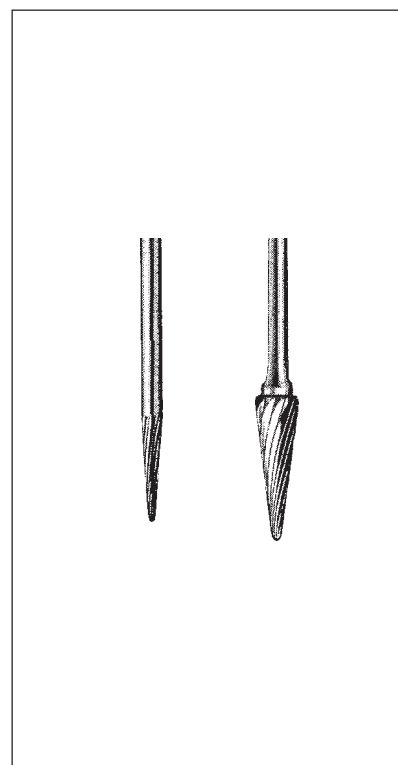
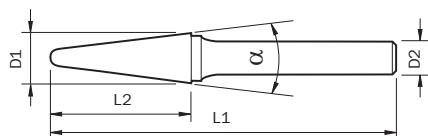

КОД	D1 mm	D2 mm	L2 mm	L1 mm	α
4263	6	3	20	55	14°
4253	5	3	16	51	14°
4243	4	3	14	49	14°
4233	3	3	14	40	14°

ХВОСТОВИК \varnothing 2,35

2263	6	2,35	20	55	14°
2253	5	2,35	16	51	14°
2243	4	2,35	14	49	14°
2220	2,35	2,35	12	40	14°

Для заказа укажите:

- Код
- Тип насечки

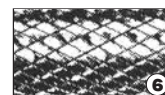
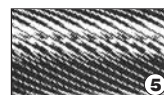
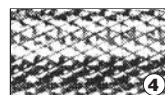
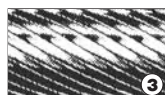
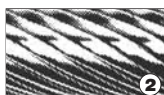

33
ПЛАМЕВИДНАЯ СО СФЕРОЙ

по DIN 8033

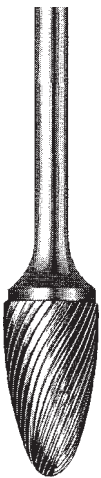

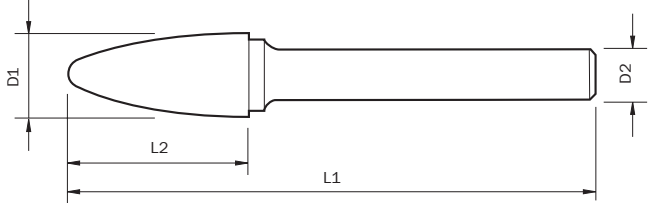

КОД	D1 mm	D2 mm	L2 mm	L1 mm
330406	4	6	14	50
330606	6	6	18	50
330806	8	6	16	61
331006	10	6	20	65
331206	12	6	25	70
331606	16	6	28	73
331608	16	8	28	73
332006	20	6	35	80
332008	20	8	35	80

Для заказа укажите:

- Код
- Тип насечки

43
МАЛАЯ ПЛАМЕВИДНАЯ СО СФЕРОЙ

по DIN 8033

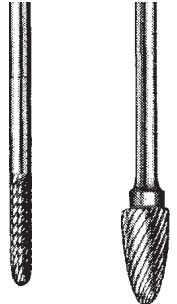

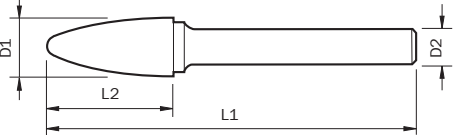

КОД	D1 mm	D2 mm	L2 mm	L1 mm
4363	6	3	14	49
4353	5	3	12	47
4343	4	3	10	45
4333	3	3	14	40

ХВОСТОВИК $\varnothing 2,35$

2363	6	2,35	14	49
2353	5	2,35	12	47
2343	4	2,35	10	45
2320	2,35	2,35	12	40

Для заказа укажите:

- Код
- Тип насечки



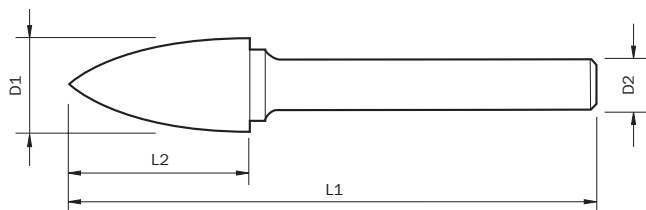

КОД	D1 mm	D2 mm	L2 mm	L1 mm
340406	4	6	14	50
340606	6	6	18	50
340806	8	6	16	61
341006	10	6	20	65
341206	12	6	25	70
341606	16	6	28	73
341608	16	8	28	73
342006	20	6	40	85
342008	20	8	40	85

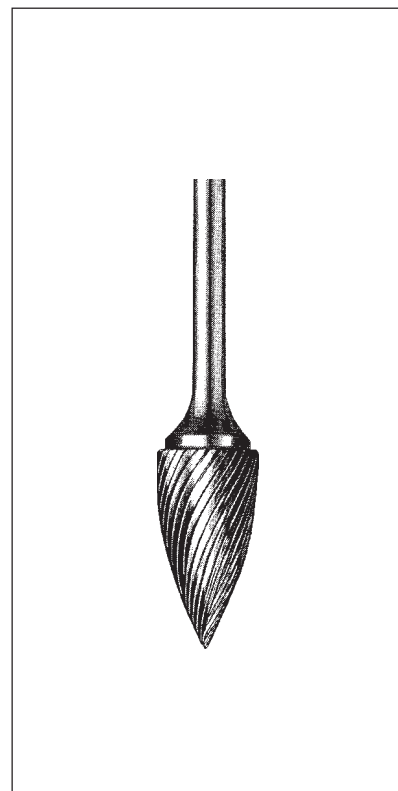

Для заказа укажите:

- Код
- Тип насечки

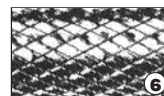
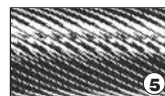
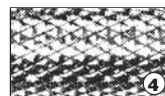
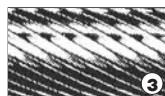
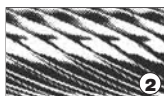

МАЛАЯ ПЛАМЕВИДНАЯ

по DIN 8033

44

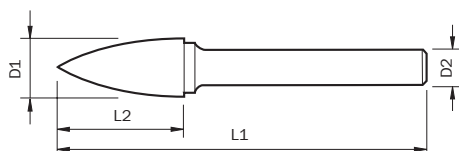

КОД	D1 mm	D2 mm	L2 mm	L1 mm
4463	6	3	14	49
4453	5	3	12	47
4443	4	3	10	45
4433	3	3	14	40

ХВОСТОВИК Ø 2,35

2463	6	2,35	14	49
2453	5	2,35	12	47
2443	4	2,35	10	45
2420	2,35	2,35	12	40

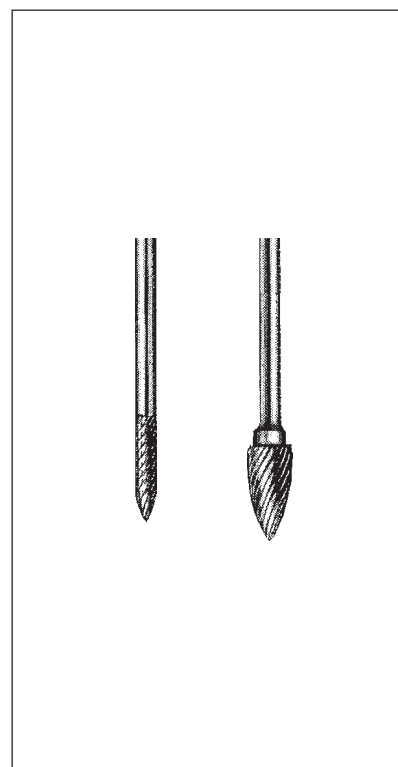

Для заказа укажите:

- Код
- Тип насечки

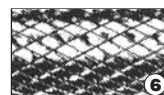
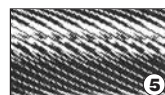
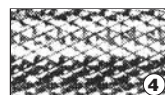
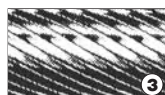
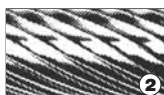

35
КОНИЧЕСКАЯ

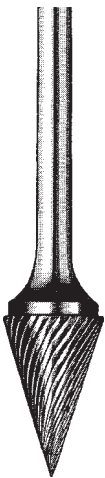

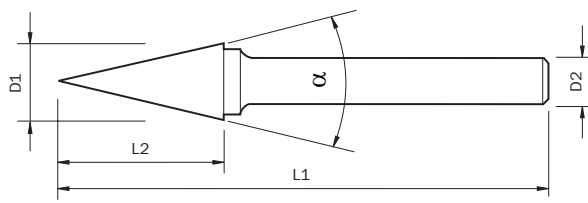

КОД	D1 mm	D2 mm	L2 mm	L1 mm	α
350406	4	6	12	50	16°
350606	6	6	18	50	16°
350806	8	6	15	60	26°
351006	10	6	18	63	28°
351206	12	6	20	65	30°
351606	16	6	22	67	38°
351608	16	8	22	67	38°
352006	20	6	24	69	45°
352008	20	8	24	69	45°

Для заказа укажите:

- Код
- Тип насечки

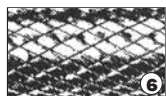
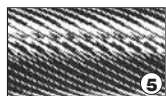
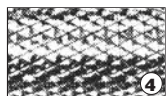
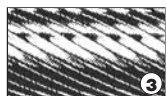
45
МАЛАЯ КОНИЧЕСКАЯ

по DIN 8033

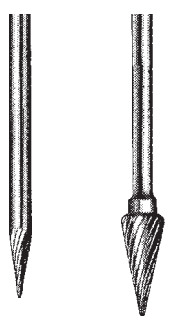

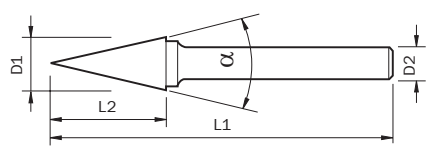

КОД	D1 mm	D2 mm	L2 mm	L1 mm	α
4563	6	3	14	49	22°
4553	5	3	12	47	22°
4543	4	3	10	45	20°
4533	3	3	14	40	10°

ХВОСТОВИК \varnothing 2,35

2563	6	2,35	14	49	22°
2553	5	2,35	12	47	22°
2543	4	2,35	10	45	20°
2520	2,35	2,35	14	40	10°

Для заказа укажите:

- Код
- Тип насечки

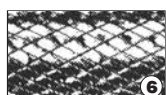
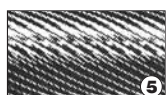
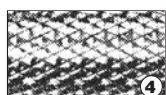
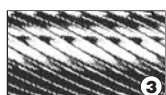
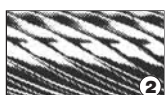

КОНИЧЕСКАЯ 90°

по DIN 8033

36

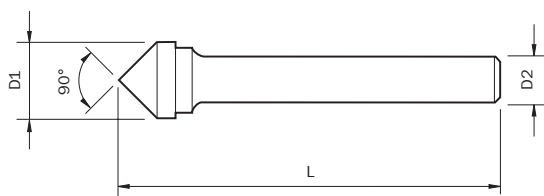

КОД	D1 mm	D2 mm	L mm
360406-90°	4	6	50
360606-90°	6	6	52
360806-90°	8	6	53
361006-90°	10	6	54
361206-90°	12	6	56
361606-90°	16	6	59
362006-90°	20	6	62
362008-90°	20	8	62

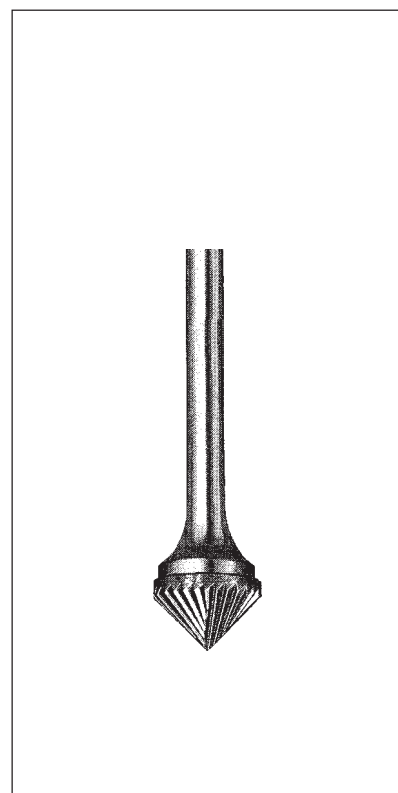

Для заказа укажите:

- Код
- Тип насечки

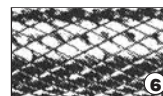
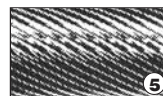
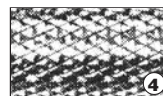
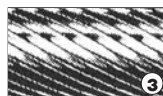
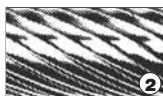

МАЛАЯ КОНИЧЕСКАЯ 90°

по DIN 8033

46

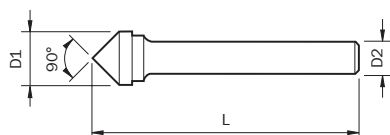

КОД	D1 mm	D2 mm	L mm
4663-90°	6	3	40
4653-90°	5	3	39
4643-90°	4	3	38
4633-90°	3	3	40
ХВОСТОВИК Ø 2,35			
2663-90°	6	2,35	40
2653-90°	5	2,35	39
2643-90°	4	2,35	38

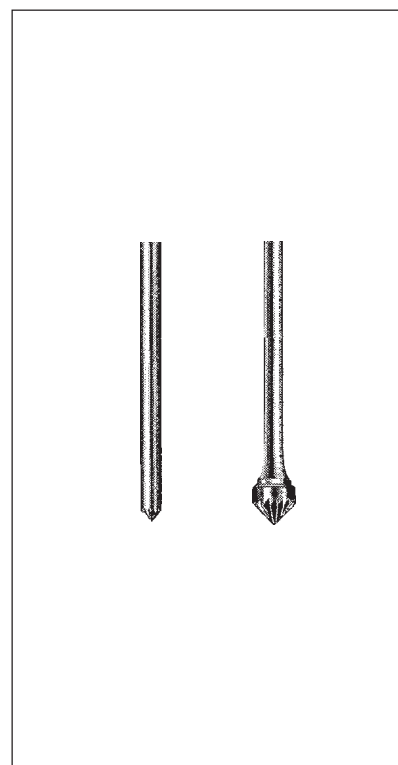

Для заказа укажите:

- Код
- Тип насечки

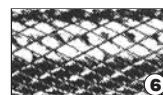
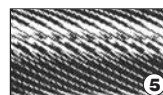
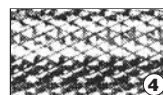
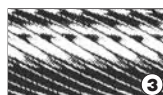
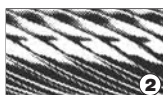

36
КОНИЧЕСКАЯ 60°

по DIN 8033

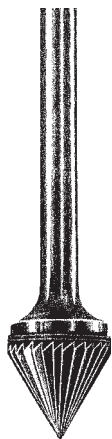
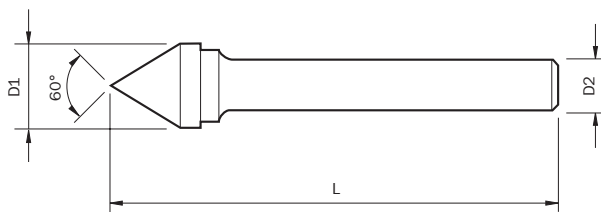

КОД	D1 mm	D2 mm	L mm
360406-60°	4	6	50
360606-60°	6	6	52
360806-60°	8	6	56
361006-60°	10	6	57
361206-60°	12	6	60
361606-60°	16	6	64
362006-60°	20	6	68
362008-60°	20	8	68

Для заказа укажите:

- Код
- Тип насечки

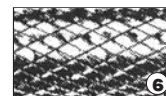
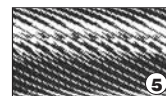
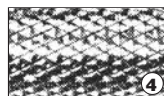
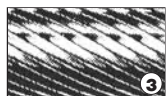
46
МАЛАЯ КОНИЧЕСКАЯ 60°

по DIN 8033

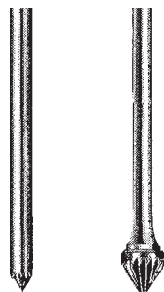
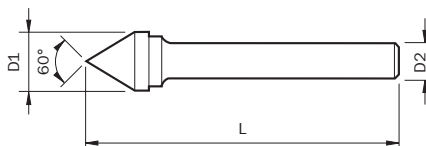

КОД	D1 mm	D2 mm	L mm
4663-60°	6	3	40
4653-60°	5	3	39
4643-60°	4	3	38
4633-60°	3	3	40
ХВОСТОВИК \varnothing 2,35			
2663-60°	6	2,35	40
2653-60°	5	2,35	39
2643-60°	4	2,35	38

Для заказа укажите:

- Код
- Тип насечки

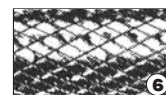
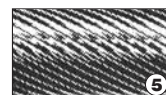
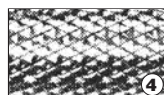
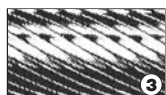
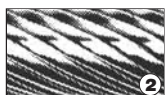

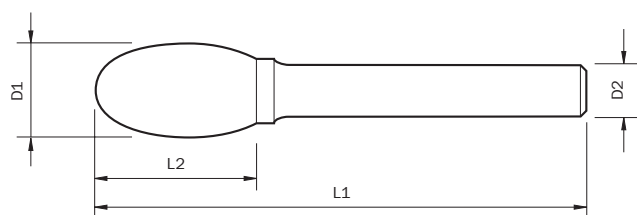

КОД	D1 mm	D2 mm	L2 mm	L1 mm
370406	4	6	6	50
370606	6	6	9	50
370806	8	6	14	59
371006	10	6	16	61
371206	12	6	21	66
371606	16	6	25	70
371608	16	8	25	70
372006	20	6	25	70
372008	20	8	25	70

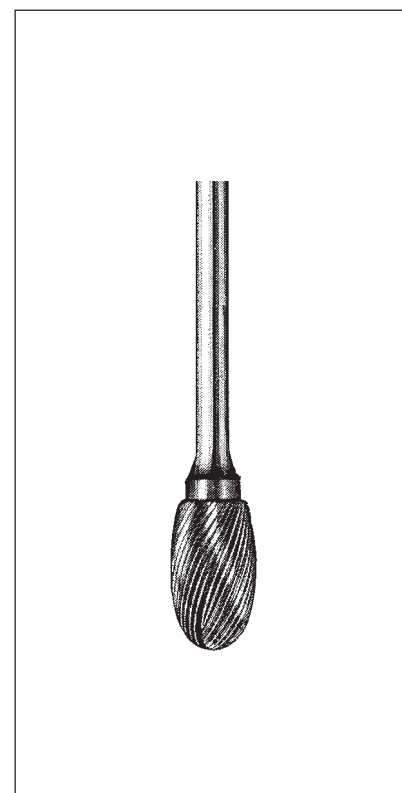

Для заказа укажите:

- Код
- Тип насечки

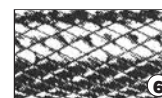
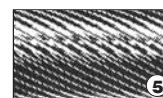
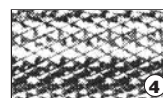
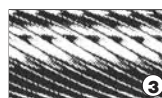
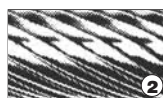

МАЛАЯ ОВАЛЬНАЯ

по DIN 8033

47

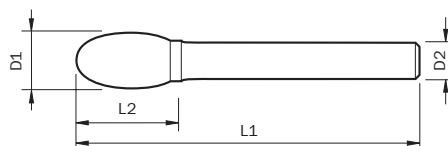

КОД	D1 mm	D2 mm	L2 mm	L1 mm
4763	6	3	9	44
4753	5	3	8	43
4743	4	3	6	41
4733	3	3	5	40

ХВОСТОВИК \varnothing 2,35

2763	6	2,35	9	44
2753	5	2,35	8	43
2743	4	2,35	6	41
2720	2,35	2,35	4	40
2715	1,5	2,35	3	40

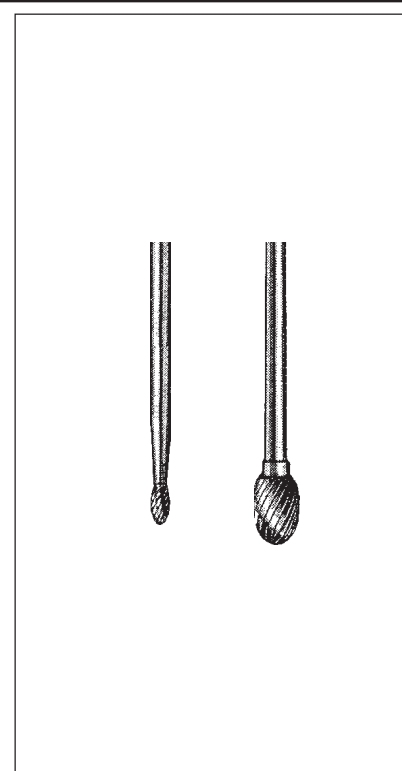

Для заказа укажите:

- Код
- Тип насечки

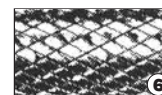
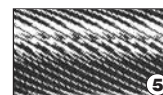
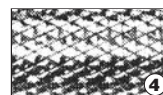
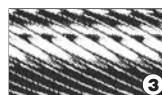
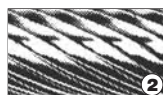

38
СФЕРИЧЕСКАЯ

по DIN 8033

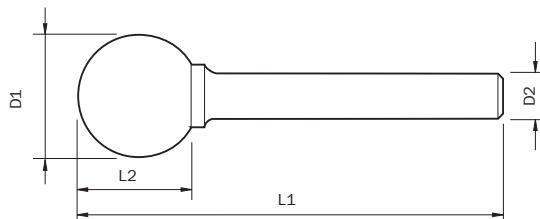
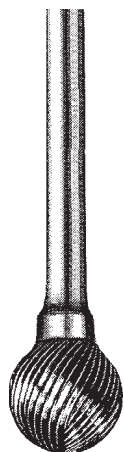

КОД	D1 mm	D2 mm	L2 mm	L1 mm
380406	4	6	3,5	50
380606	6	6	5	50
380806	8	6	7	52
381006	10	6	9	54
381206	12	6	11	56
381606	16	6	15	60
381608	16	8	15	60
382006	20	6	18	63
382008	20	8	18	63

Для заказа укажите:

- Код
- Тип насечки

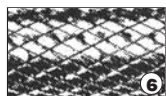
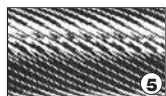
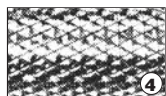
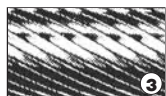
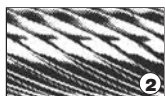
48
МАЛАЯ СФЕРИЧЕСКАЯ

по DIN 8033

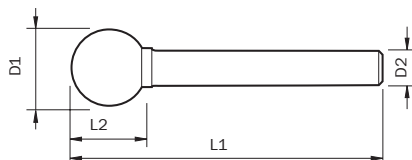
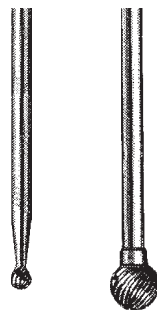

КОД	D1 mm	D2 mm	L2 mm	L1 mm
4863	6	3	5	40
4853	5	3	4	39
4843	4	3	3,5	38,5
4833	3	3	2,5	40
4825	2,5	3	2	40
4820	2	3	1,5	40
4815	1,5	3	1	40

ХВОСТОВИК Ø 2,35

2863	6	2,35	5	40
2853	5	2,35	4	39
2843	4	2,35	3,5	38,5
2820	2,35	2,35	1,5	40
2815	1,5	2,35	1	40

Для заказа укажите:

- Код
- Тип насечки

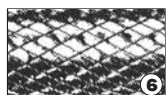
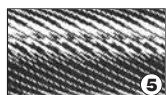
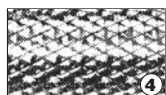
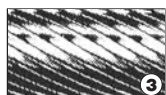
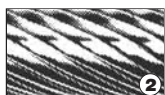

ОБРАТНЫЙ КОНУС 15°

по DIN 8033

39

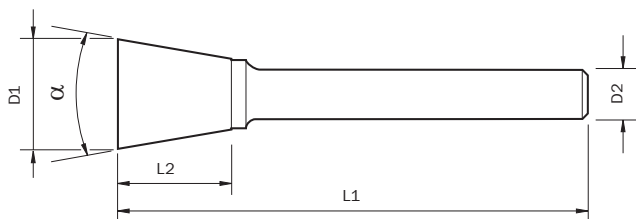

КОД	D1 mm	D2 mm	L2 mm	L1 mm	α
390406	4	6	4	50	15°
390606	6	6	6	50	15°
390806	8	6	8	53	15°
391006	10	6	10	55	15°
391206	12	6	12	57	15°
391606	16	6	16	61	15°
392006	20	6	20	65	15°
392008	20	8	20	65	15°

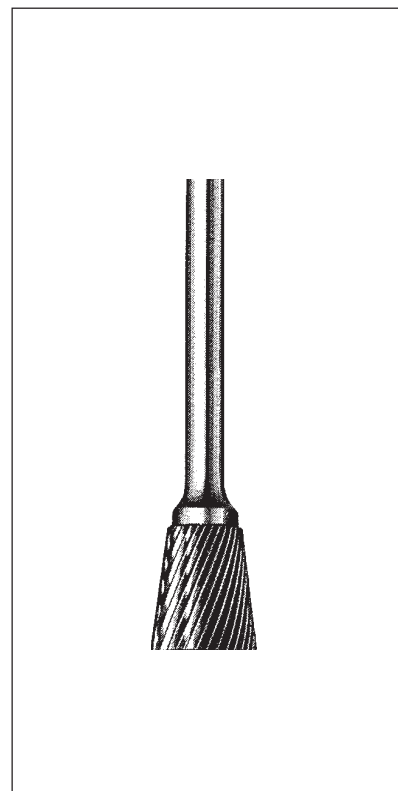

Для заказа укажите:

- Код
- Тип насечки

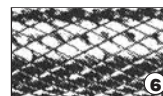
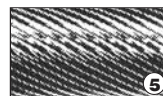
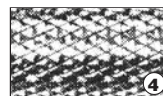
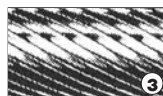
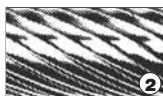

МАЛАЯ ОБРАТНЫЙ КОНУС 15°

по DIN 8033

49

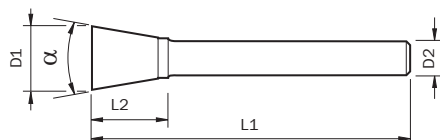

КОД	D1 mm	D2 mm	L2 mm	L1 mm	α
4963	6	3	6	41	15°
4953	5	3	5	40	15°
4943	4	3	4	39	15°
4933	3	3	3	40	15°

ХВОСТОВИК \varnothing 2,35

2963	6	2,35	6	41	15°
2953	5	2,35	5	40	15°
2943	4	2,35	4	39	15°
2920	2,35	2,35	2,5	40	15°
2915	1,5	2,35	1,5	40	15°

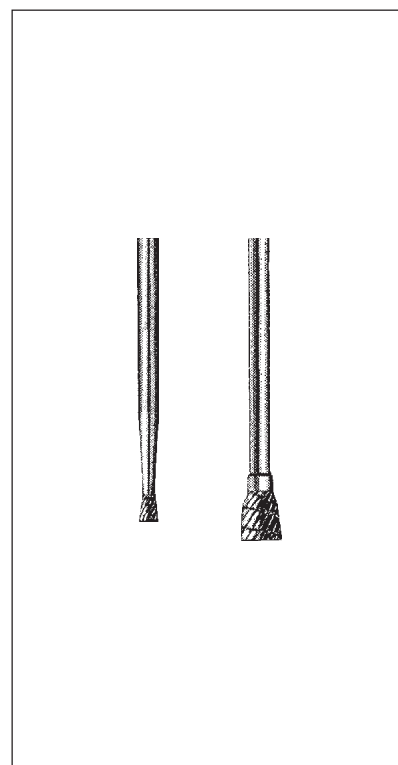

Для заказа укажите:

- Код
- Тип насечки

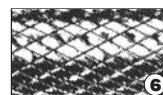
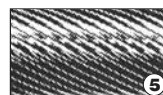
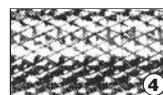
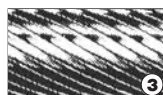
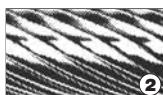

39ST
ОБРАТНЫЙ КОНУС 15° С ТОРЦЕВОЙ НАСЕЧКОЙ

по DIN 8033

КОД	D1 mm	D2 mm	L2 mm	L1 mm	α
390406-ST	4	6	4	50	15°
390606-ST	6	6	6	50	15°
390806-ST	8	6	8	53	15°
391006-ST	10	6	10	55	15°
391206-ST	12	6	12	57	15°
391606-ST	16	6	16	61	15°
392006-ST	20	6	20	65	15°
392008-ST	20	8	20	65	15°

Для заказа укажите:

- Код
- Тип насечки

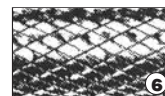
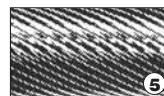
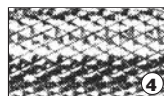
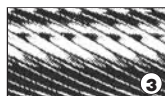
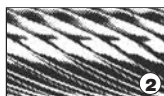
49ST
МАЛАЯ ОБРАТНЫЙ КОНУС 15° С ТОРЦЕВОЙ НАСЕЧКОЙ

по DIN 8033

КОД	D1 mm	D2 mm	L2 mm	L1 mm	α
4963-ST	6	3	6	41	15°
4953-ST	5	3	5	40	15°
4943-ST	4	3	4	39	15°
4933-ST	3	3	3	40	15°

ХВОСТОВИК \varnothing 2,35

2963-ST	6	2,35	6	41	15°
2953-ST	5	2,35	5	40	15°
2943-ST	4	2,35	4	39	15°
2920-ST	2,35	2,35	2,5	40	15°
2915-ST	1,5	2,35	1,5	40	15°

Для заказа укажите:

- Код
- Тип насечки

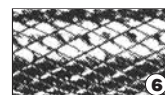
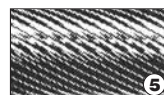
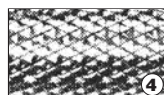
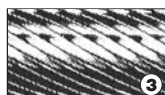
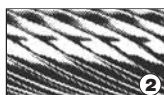

НАБОРЫ И ДОПОЛНИТЕЛЬНЫЕ АКСЕССУАРЫ

НАБОР №10



Набор №10 состоит из борфрез:
**4033-4133-4233-4333-4433-
 4533-4633-4733-4833-4933**
 Изготавливаются наборы с насечками:
 3 - 4 - 5 - 6

НАБОР №11



Набор №11 состоит из борфрез:
**4063-4163-4263-4363-4463-
 4563-4663-4763-4863-4963**
 Изготавливаются наборы с насечками:
 2 - 3 - 4 - 5 - 6

НАБОР №12



Набор №12 состоит из борфрез:
**300606-310606-320606-330606-
 340606-350606-360606-370606-
 380606-390606**
 Изготавливаются наборы с насечками:
 1 - 2 - 3 - 4 - 5 - 6

НАБОР №13



Набор №13 состоит из борфрез: **301206/1 - 311206/2 - 321206/3 -
 331206/4 - 341206/5 - 351206/3SP - 361206/3 - 371206/3 - 381206/6 -
 391206/3** и пневмошлифмашины: **SMS30DCZ**.



СПЕЦИАЛЬНЫЕ БОРФРЕЗЫ

По заказу, борфрезы могут быть снабжены более длинным хвостовиком до 300 мм. Борфрезы с гибкими хвостовиками могут использоваться для обработки в искривленных каналах, которые являются недостижимыми для другого типа инструмента. В этом случае, скорость резания должна быть уменьшена по крайней мере на 30%.

РЕЖИМЫ РЕЗАНИЯ

